

## C503B-Rxx, C503B-Axx: 5-mm Round Red & Amber LEDs

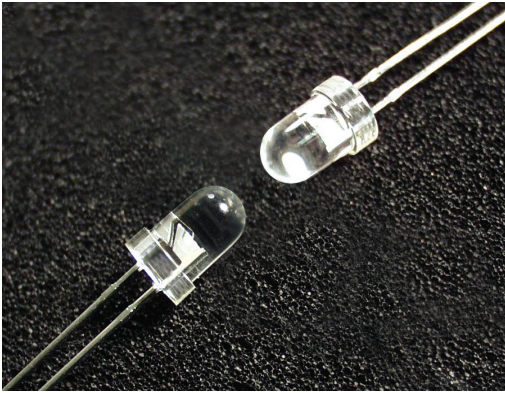

### PRODUCT DESCRIPTION

Round LEDs offer superior light output for excellent readability in sunlight and dependable performance. They provide extremely stable light output over long periods of time.

These lamps are made with an advanced optical-grade epoxy offering superior high-temperature and high-moisture-resistance performance in outdoor signal and sign applications.

### FEATURES

- Size (mm): 5
- Color and Typical Dominant Wavelength:  
Red (624nm)  
Amber (591nm)
- Luminous Intensity (mcd)  
C503B-RAS/RAN:(8200 - 32900)  
C503B-RBS/RBN:(3000 - 12000)  
C503B-RCS/RCN:(3000 - 12000)  
C503B-AAS/AAN:(5860 - 23500)  
C503B-ABS/ABN:(3000 - 12000)  
C503B-ACS/ACN:(4180 - 12000)
- Viewing angles:  
15°: C503B-RAS/RAN/AAS/AAN  
23°: C503B-RBS/RBN/ABS/ABN  
30°: C503B-RCS/RCN/ACS/ACN
- Lead - Free
- RoHS Compliant

### APPLICATIONS

- Electronic Signs & Signals (ESS)
- Motorway Signs
- Variable Message Sign (VMS)
- Advertising Signs
- Petrol Signs
- Amusement

**ABSOLUTE MAXIMUM RATINGS ( $T_A = 25^\circ\text{C}$ )**

| Items   | Symbol    | Absolute Maximum Rating   | Unit             |
|---|-----------|---|------------------|
|   |           | Red/Amber   |                  |
| Forward Current                                       | $I_F$     | 50 <sup>Note1</sup>   | mA               |
| Peak Forward Current <sup>Note2</sup>                 | $I_{FP}$  | 200   | mA               |
| Reverse Voltage                                       | $V_R$     | 5   | V                |
| Power Dissipation                                     | $P_D$     | 130   | mW               |
| Operation Temperature                                 | $T_{opr}$ | -40 ~ +100  | $^\circ\text{C}$ |
| Storage Temperature                                   | $T_{stg}$ | -40 ~ +100  | $^\circ\text{C}$ |
| Lead Soldering Temperature                            | $T_{sol}$ | Max. 260 $^\circ\text{C}$ for 3 sec. max.<br>(3 mm from the base of the epoxy bulb) |                  |
| Electrostatic Discharge Classification (MIL-STD-883E) | ESD       | Class 2   |                  |

**Note:**

- For long term performance the drive currents between 10mA and 30mA are recommended. Please contact Cree LED sales representative for more information on recommended drive conditions.
- Pulse width  $\leq 0.1$  msec, duty  $\leq 1/10$ .

**TYPICAL ELECTRICAL & OPTICAL CHARACTERISTICS ( $T_A = 25^\circ\text{C}$ )**

| Characteristics     | Color                 | Symbol                    | Condition       | Unit          | Minimum | Typical | Maximum |
|---------------------|-----------------------|---------------------------|-----------------|---------------|---------|---------|---------|
| Forward Voltage     | Red/Amber             | $V_F$                     | $I_F = 20$ mA   | V             |         | 2.1     | 2.6     |
| Reverse Current     | Red/Amber             | $I_R$                     | $V_R = 5$ V     | $\mu\text{A}$ |         |         | 100     |
| Dominant Wavelength | Red                   | $\lambda_D$               | $I_F = 20$ mA   | nm            | 618     | 624     | 630     |
|                     | Amber                 | $\lambda_D$               | $I_F = 20$ mA   | nm            | 584     | 591     | 596     |
| Luminous Intensity  | Red                   | C503B-RAS/RAN (15 degree) | $I_V$           | $I_F = 20$ mA | mcd     | 8200    | 15000   |
|                     |                       | C503B-RBS/RBN (23 degree) | $I_V$           | $I_F = 20$ mA | mcd     | 3000    | 5000    |
|                     |                       | C503B-RCS/RCN (30 degree) | $I_V$           | $I_F = 20$ mA | mcd     | 3000    | 5100    |
|                     | Amber                 | C503B-AAS/AAN (15 degree) | $I_V$           | $I_F = 20$ mA | mcd     | 5860    | 13000   |
|                     |                       | C503B-ABS/ABN (23 degree) | $I_V$           | $I_F = 20$ mA | mcd     | 3000    | 5000    |
|                     |                       | C503B-ACS/ACN (30 degree) | $I_V$           | $I_F = 20$ mA | mcd     | 4180    | 6000    |
| 50% Power Angle     | C503B-RAS/RAN/AAS/AAN |                           | $2\theta_{1/2}$ | $I_F = 20$ mA | deg     | 15      |         |
|                     | C503B-RBS/RBN/ABS/ABN |                           | $2\theta_{1/2}$ | $I_F = 20$ mA | deg     | 23      |         |
|                     | C503B-RCS/RCN/ACS/ACN |                           | $2\theta_{1/2}$ | $I_F = 20$ mA | deg     | 30      |         |

\* Continuous reverse voltage can cause LED damage.

## INTENSITY BIN LIMIT

### Red

| 15° (20 mA) - C503B-RAS/RAN |           |           | 23° (20 mA) - C503B-RBS/RBN |           |           | 30° (20 mA) - C503B-RCS/RCN |           |           |
|-----------------------------|-----------|-----------|-----------------------------|-----------|-----------|-----------------------------|-----------|-----------|
| Bin Code                    | Min.(mcd) | Max.(mcd) | Bin Code                    | Min.(mcd) | Max.(mcd) | Bin Code                    | Min.(mcd) | Max.(mcd) |
| Z0                          | 8200      | 12000     | W0                          | 3000      | 4180      | W0                          | 3000      | 4180      |
| A0                          | 12000     | 16800     | X0                          | 4180      | 5860      | X0                          | 4180      | 5860      |
| B0                          | 16800     | 23500     | Y0                          | 5860      | 8200      | Y0                          | 5860      | 8200      |
| C0                          | 23500     | 32900     | Z0                          | 8200      | 12000     | Z0                          | 8200      | 12000     |

### Amber

| 15° (20 mA) - C503B-AAS/AAN |           |           | 23° (20 mA) - C503B-ABS/ABN |           |           | 30° (20 mA) - C503B-ACS/ACN |           |           |
|-----------------------------|-----------|-----------|-----------------------------|-----------|-----------|-----------------------------|-----------|-----------|
| Bin Code                    | Min.(mcd) | Max.(mcd) | Bin Code                    | Min.(mcd) | Max.(mcd) | Bin Code                    | Min.(mcd) | Max.(mcd) |
| Y0                          | 5860      | 8200      | W0                          | 3000      | 4180      | X0                          | 4180      | 5860      |
| Z0                          | 8200      | 12000     | X0                          | 4180      | 5860      | Y0                          | 5860      | 8200      |
| A0                          | 12000     | 16800     | Y0                          | 5860      | 8200      | Z0                          | 8200      | 12000     |
| B0                          | 16800     | 23500     | Z0                          | 8200      | 12000     |                             |           |           |

\* Tolerance of measurement of luminous intensity is  $\pm 15\%$

## COLOR BIN LIMIT

| Red (20 mA) - C503B-Rxx |          |          | Amber (20 mA) - C503B-Axx |          |          |
|-------------------------|----------|----------|---------------------------|----------|----------|
| Bin Code                | Min.(nm) | Max.(nm) | Bin Code                  | Min.(nm) | Max.(nm) |
| RA                      | 618      | 630      | A2                        | 584      | 587      |
|                         |          |          | A3                        | 587      | 590      |
|                         |          |          | A4                        | 590      | 593      |
|                         |          |          | A5                        | 593      | 596      |

\* Tolerance of measurement of dominant wavelength is  $\pm 1$  nm.

## ORDER CODE TABLE

| Color              | Viewing Angle      | Order Code         | Luminous Intensity (mcd) |       | Dominant Wavelength |          |           |          | Package | Standoff |
|--------------------|--------------------|--------------------|--------------------------|-------|---------------------|----------|-----------|----------|---------|----------|
|                    |                    |                    | Min.                     | Max.  | Color Bin           | Min.(nm) | Color Bin | Max.(nm) |         |          |
| Red                | 15°                | C503B-RAS-CZ0C0AA1 | 8200                     | 32900 | RA                  | 618      | RA        | 630      | Bulk    | Yes      |
|                    |                    | C503B-RAS-CA0C0AA1 | 12000                    | 32900 | RA                  | 618      | RA        | 630      | Bulk    | Yes      |
|                    |                    | C503B-RAS-CA0B0AA1 | 12000                    | 23500 | RA                  | 618      | RA        | 630      | Bulk    | Yes      |
|                    |                    | C503B-RAN-CZ0C0AA1 | 8200                     | 32900 | RA                  | 618      | RA        | 630      | Bulk    | No       |
|                    |                    | C503B-RAN-CA0C0AA1 | 12000                    | 32900 | RA                  | 618      | RA        | 630      | Bulk    | No       |
|                    |                    | C503B-RAN-CA0B0AA1 | 12000                    | 23500 | RA                  | 618      | RA        | 630      | Bulk    | No       |
|                    |                    | C503B-RAS-CZ0C0AA2 | 8200                     | 32900 | RA                  | 618      | RA        | 630      | Ammo    | Yes      |
|                    |                    | C503B-RAS-CA0C0AA2 | 12000                    | 32900 | RA                  | 618      | RA        | 630      | Ammo    | Yes      |
|                    |                    | C503B-RAS-CA0B0AA2 | 12000                    | 23500 | RA                  | 618      | RA        | 630      | Ammo    | Yes      |
|                    |                    | C503B-RAN-CZ0C0AA2 | 8200                     | 32900 | RA                  | 618      | RA        | 630      | Ammo    | No       |
|                    |                    | C503B-RAN-CA0C0AA2 | 12000                    | 32900 | RA                  | 618      | RA        | 630      | Ammo    | No       |
|                    | C503B-RAN-CA0B0AA2 | 12000              | 23500                    | RA    | 618                 | RA       | 630       | Ammo     | No      |          |
|                    | 23°                | C503B-RBS-CW0Z0AA1 | 3000                     | 12000 | RA                  | 618      | RA        | 630      | Bulk    | Yes      |
|                    |                    | C503B-RBS-CX0Y0AA1 | 4180                     | 8200  | RA                  | 618      | RA        | 630      | Bulk    | Yes      |
|                    |                    | C503B-RBS-CY0Z0AA1 | 5860                     | 12000 | RA                  | 618      | RA        | 630      | Bulk    | Yes      |
|                    |                    | C503B-RBN-CW0Z0AA1 | 3000                     | 12000 | RA                  | 618      | RA        | 630      | Bulk    | No       |
|                    |                    | C503B-RBN-CX0Y0AA1 | 4180                     | 8200  | RA                  | 618      | RA        | 630      | Bulk    | No       |
|                    |                    | C503B-RBN-CY0Z0AA1 | 5860                     | 12000 | RA                  | 618      | RA        | 630      | Bulk    | No       |
|                    |                    | C503B-RBS-CW0Z0AA2 | 3000                     | 12000 | RA                  | 618      | RA        | 630      | Ammo    | Yes      |
|                    |                    | C503B-RBS-CX0Y0AA2 | 4180                     | 8200  | RA                  | 618      | RA        | 630      | Ammo    | Yes      |
|                    |                    | C503B-RBS-CY0Z0AA2 | 5860                     | 12000 | RA                  | 618      | RA        | 630      | Ammo    | Yes      |
|                    |                    | C503B-RBN-CW0Z0AA2 | 3000                     | 12000 | RA                  | 618      | RA        | 630      | Ammo    | No       |
| C503B-RBN-CX0Y0AA2 |                    | 4180               | 8200                     | RA    | 618                 | RA       | 630       | Ammo     | No      |          |
| C503B-RBN-CY0Z0AA2 | 5860               | 12000              | RA                       | 618   | RA                  | 630      | Ammo      | No       |         |          |

## Notes:

- The above kit numbers represent order codes that include multiple intensity-bin and color-bin codes. Only one intensity-bin code and one color-bin code will be shipped on each bulk. Single intensity-bin code and single color-bin codes will not be orderable.
- Please refer to the [HB LED Lamp Reliability Test Standards](#) document for reliability test conditions.
- Please refer to the [HB LED Lamp Soldering & Handling](#) document for information about how to use this LED product safely.

## ORDER CODE TABLE

| Color | Viewing Angle | Order Code         | Luminous Intensity (mcd) |       | Dominant Wavelength |          |           |          | Package | Standoff |
|-------|---------------|--------------------|--------------------------|-------|---------------------|----------|-----------|----------|---------|----------|
|       |               |                    | Min.                     | Max.  | Color Bin           | Min.(nm) | Color Bin | Max.(nm) |         |          |
| Red   | 30°           | C503B-RCS-CW0Z0AA1 | 3000                     | 12000 | RA                  | 618      | RA        | 630      | Bulk    | Yes      |
|       |               | C503B-RCS-CW0X0AA1 | 3000                     | 5860  | RA                  | 618      | RA        | 630      | Bulk    | Yes      |
|       |               | C503B-RCS-CX0Y0AA1 | 4180                     | 8200  | RA                  | 618      | RA        | 630      | Bulk    | Yes      |
|       |               | C503B-RCN-CW0Z0AA1 | 3000                     | 12000 | RA                  | 618      | RA        | 630      | Bulk    | No       |
|       |               | C503B-RCN-CW0X0AA1 | 3000                     | 5860  | RA                  | 618      | RA        | 630      | Bulk    | No       |
|       |               | C503B-RCN-CX0Y0AA1 | 4180                     | 8200  | RA                  | 618      | RA        | 630      | Bulk    | No       |
|       |               | C503B-RCS-CW0Z0AA2 | 3000                     | 12000 | RA                  | 618      | RA        | 630      | Ammo    | Yes      |
|       |               | C503B-RCS-CW0X0AA2 | 3000                     | 5860  | RA                  | 618      | RA        | 630      | Ammo    | Yes      |
|       |               | C503B-RCS-CX0Y0AA2 | 4180                     | 8200  | RA                  | 618      | RA        | 630      | Ammo    | Yes      |
|       |               | C503B-RCN-CW0Z0AA2 | 3000                     | 12000 | RA                  | 618      | RA        | 630      | Ammo    | No       |
|       |               | C503B-RCN-CW0X0AA2 | 3000                     | 5860  | RA                  | 618      | RA        | 630      | Ammo    | No       |
|       |               | C503B-RCN-CX0Y0AA2 | 4180                     | 8200  | RA                  | 618      | RA        | 630      | Ammo    | No       |

## Notes:

- The above kit numbers represent order codes that include multiple intensity-bin and color-bin codes. Only one intensity-bin code and one color-bin code will be shipped on each bulk. Single intensity-bin code and single color-bin codes will not be orderable.
- Please refer to the [HB LED Lamp Reliability Test Standards](#) document for reliability test conditions.
- Please refer to the [HB LED Lamp Soldering & Handling](#) document for information about how to use this LED product safely.

## ORDER CODE TABLE

| Color              | Viewing Angle | Order Code         | Luminous Intensity (mcd) |       | Dominant Wavelength |          |           |          | Package | Standoff |
|--------------------|---------------|--------------------|--------------------------|-------|---------------------|----------|-----------|----------|---------|----------|
|                    |               |                    | Min.                     | Max.  | Color Bin           | Min.(nm) | Color Bin | Max.(nm) |         |          |
| Amber              | 15°           | C503B-AAS-CY0B0251 | 5860                     | 23500 | A2                  | 584      | A5        | 596      | Bulk    | Yes      |
|                    |               | C503B-AAS-CZ0B0341 | 8200                     | 23500 | A3                  | 587      | A4        | 593      | Bulk    | Yes      |
|                    |               | C503B-AAS-CA0B0341 | 12000                    | 23500 | A3                  | 587      | A4        | 593      | Bulk    | Yes      |
|                    |               | C503B-AAN-CY0B0251 | 5860                     | 23500 | A2                  | 584      | A5        | 596      | Bulk    | No       |
|                    |               | C503B-AAN-CZ0B0341 | 8200                     | 23500 | A3                  | 587      | A4        | 593      | Bulk    | No       |
|                    |               | C503B-AAN-CA0B0341 | 12000                    | 23500 | A3                  | 587      | A4        | 593      | Bulk    | No       |
|                    |               | C503B-AAS-CY0B0252 | 5860                     | 23500 | A2                  | 584      | A5        | 596      | Ammo    | Yes      |
|                    |               | C503B-AAS-CZ0B0342 | 8200                     | 23500 | A3                  | 587      | A4        | 593      | Ammo    | Yes      |
|                    |               | C503B-AAS-CA0B0342 | 12000                    | 23500 | A3                  | 587      | A4        | 593      | Ammo    | Yes      |
|                    |               | C503B-AAN-CY0B0252 | 5860                     | 23500 | A2                  | 584      | A5        | 596      | Ammo    | No       |
|                    |               | C503B-AAN-CZ0B0342 | 8200                     | 23500 | A3                  | 587      | A4        | 593      | Ammo    | No       |
|                    |               | C503B-AAN-CA0B0342 | 12000                    | 23500 | A3                  | 587      | A4        | 593      | Ammo    | No       |
|                    | 23°           | C503B-ABS-CW0Z0251 | 3000                     | 12000 | A2                  | 584      | A5        | 596      | Bulk    | Yes      |
|                    |               | C503B-ABS-CX0Y0341 | 4180                     | 8200  | A3                  | 587      | A4        | 593      | Bulk    | Yes      |
|                    |               | C503B-ABS-CY0Z0341 | 5860                     | 12000 | A3                  | 587      | A4        | 593      | Bulk    | Yes      |
|                    |               | C503B-ABN-CW0Z0251 | 3000                     | 12000 | A2                  | 584      | A5        | 596      | Bulk    | No       |
|                    |               | C503B-ABN-CX0Y0341 | 4180                     | 8200  | A3                  | 587      | A4        | 593      | Bulk    | No       |
|                    |               | C503B-ABN-CY0Z0341 | 5860                     | 12000 | A3                  | 587      | A4        | 593      | Bulk    | No       |
|                    |               | C503B-ABS-CW0Z0252 | 3000                     | 12000 | A2                  | 584      | A5        | 596      | Ammo    | Yes      |
|                    |               | C503B-ABS-CX0Y0342 | 4180                     | 8200  | A3                  | 587      | A4        | 593      | Ammo    | Yes      |
|                    |               | C503B-ABS-CY0Z0342 | 5860                     | 12000 | A3                  | 587      | A4        | 593      | Ammo    | Yes      |
|                    |               | C503B-ABN-CW0Z0252 | 3000                     | 12000 | A2                  | 584      | A5        | 596      | Ammo    | No       |
| C503B-ABN-CX0Y0342 | 4180          | 8200               | A3                       | 587   | A4                  | 593      | Ammo      | No       |         |          |
| C503B-ABN-CY0Z0342 | 5860          | 12000              | A3                       | 587   | A4                  | 593      | Ammo      | No       |         |          |

## Notes:

- The above kit numbers represent order codes that include multiple intensity-bin and color-bin codes. Only one intensity-bin code and one color-bin code will be shipped on each bulk. Single intensity-bin code and single color-bin codes will not be orderable.
- Please refer to the [HB LED Lamp Reliability Test Standards](#) document for reliability test conditions.
- Please refer to the [HB LED Lamp Soldering & Handling](#) document for information about how to use this LED product safely.

## ORDER CODE TABLE

| Color              | Viewing Angle | Order Code         | Luminous Intensity (mcd) |       | Dominant Wavelength |          |           |          | Package | Standoff |
|--------------------|---------------|--------------------|--------------------------|-------|---------------------|----------|-----------|----------|---------|----------|
|                    |               |                    | Min.                     | Max.  | Color Bin           | Min.(nm) | Color Bin | Max.(nm) |         |          |
| Amber              | 30°           | C503B-ACS-CX0Z0251 | 4180                     | 12000 | A2                  | 584      | A5        | 596      | Bulk    | Yes      |
|                    |               | C503B-ACS-CX0Z0341 | 4180                     | 12000 | A3                  | 587      | A4        | 593      | Bulk    | Yes      |
|                    |               | C503B-ACS-CX0Y0251 | 4180                     | 8200  | A2                  | 584      | A5        | 596      | Bulk    | Yes      |
|                    |               | C503B-ACS-CX0Y0341 | 4180                     | 8200  | A3                  | 587      | A4        | 593      | Bulk    | Yes      |
|                    |               | C503B-ACS-CY0Z0251 | 5860                     | 12000 | A2                  | 584      | A5        | 596      | Bulk    | Yes      |
|                    |               | C503B-ACS-CY0Z0341 | 5860                     | 12000 | A3                  | 587      | A4        | 593      | Bulk    | Yes      |
|                    |               | C503B-ACN-CX0Z0251 | 4180                     | 12000 | A2                  | 584      | A5        | 596      | Bulk    | No       |
|                    |               | C503B-ACN-CX0Z0341 | 4180                     | 12000 | A3                  | 587      | A4        | 593      | Bulk    | No       |
|                    |               | C503B-ACN-CX0Y0251 | 4180                     | 8200  | A2                  | 584      | A5        | 596      | Bulk    | No       |
|                    |               | C503B-ACN-CX0Y0341 | 4180                     | 8200  | A3                  | 587      | A4        | 593      | Bulk    | No       |
|                    |               | C503B-ACN-CY0Z0251 | 5860                     | 12000 | A2                  | 584      | A5        | 596      | Bulk    | No       |
|                    |               | C503B-ACN-CY0Z0341 | 5860                     | 12000 | A3                  | 587      | A4        | 593      | Bulk    | No       |
|                    |               | C503B-ACS-CX0Z0252 | 4180                     | 12000 | A2                  | 584      | A5        | 596      | Ammo    | Yes      |
|                    |               | C503B-ACS-CX0Z0342 | 4180                     | 12000 | A3                  | 587      | A4        | 593      | Ammo    | Yes      |
|                    |               | C503B-ACS-CX0Y0252 | 4180                     | 8200  | A2                  | 584      | A5        | 596      | Ammo    | Yes      |
|                    |               | C503B-ACS-CX0Y0342 | 4180                     | 8200  | A3                  | 587      | A4        | 593      | Ammo    | Yes      |
|                    |               | C503B-ACS-CY0Z0252 | 5860                     | 12000 | A2                  | 584      | A5        | 596      | Ammo    | Yes      |
|                    |               | C503B-ACS-CY0Z0342 | 5860                     | 12000 | A3                  | 587      | A4        | 593      | Ammo    | Yes      |
|                    |               | C503B-ACN-CX0Z0252 | 4180                     | 12000 | A2                  | 584      | A5        | 596      | Ammo    | No       |
|                    |               | C503B-ACN-CX0Z0342 | 4180                     | 12000 | A3                  | 587      | A4        | 593      | Ammo    | No       |
| C503B-ACN-CX0Y0252 | 4180          | 8200               | A2                       | 584   | A5                  | 596      | Ammo      | No       |         |          |
| C503B-ACN-CX0Y0342 | 4180          | 8200               | A3                       | 587   | A4                  | 593      | Ammo      | No       |         |          |
| C503B-ACN-CY0Z0252 | 5860          | 12000              | A2                       | 584   | A5                  | 596      | Ammo      | No       |         |          |
| C503B-ACN-CY0Z0342 | 5860          | 12000              | A3                       | 587   | A4                  | 593      | Ammo      | No       |         |          |

## Notes:

- The above kit numbers represent order codes that include multiple intensity-bin and color-bin codes. Only one intensity-bin code and one color-bin code will be shipped on each bulk. Single intensity-bin code and single color-bin codes will not be orderable.
- Please refer to the [HB LED Lamp Reliability Test Standards](#) document for reliability test conditions.
- Please refer to the [HB LED Lamp Soldering & Handling](#) document for information about how to use this LED product safely.

## GRAPHS

The data below are collected from statistical figures that do not necessarily correspond to the actual parameters of each single LED. Hence, these data will be changed without further notice.

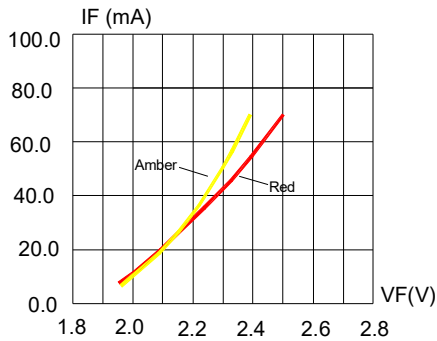

FIG.1 FORWARD CURRENT VS. FORWARD VOLTAGE.

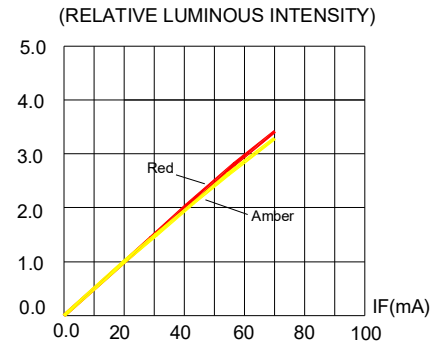

FIG.2 RELATIVE LUMINOUS INTENSITY VS. FORWARD CURRENT

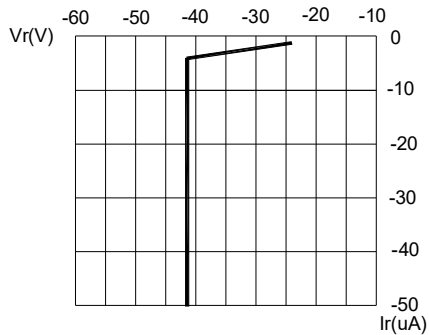

FIG.3 RED & AMBER REVERSE CURRENT VS. REVERSE VOLTAGE.

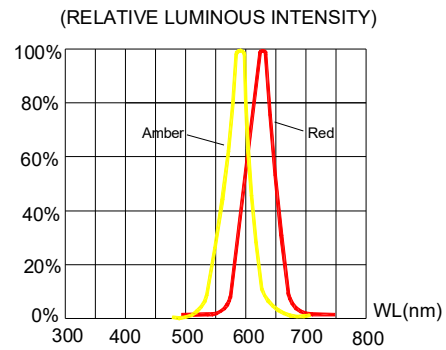

FIG.4 RELATIVE LUMINOUS INTENSITY VS. WAVELENGTH.

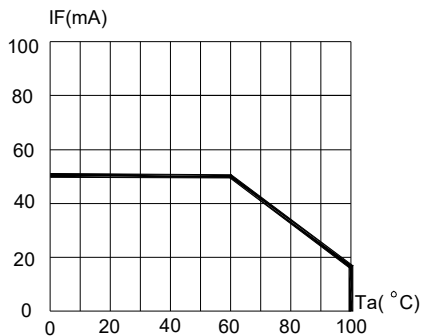
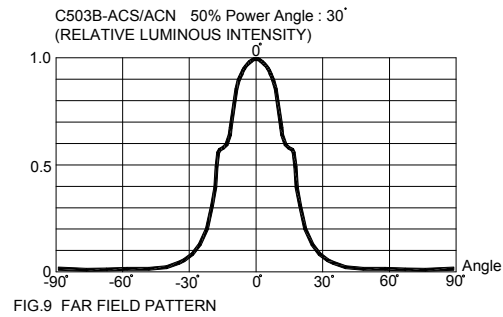
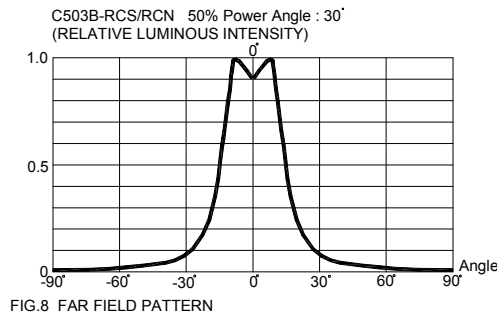
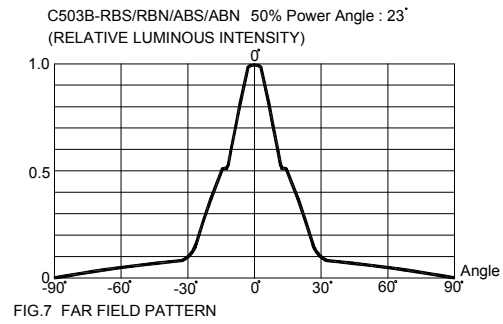
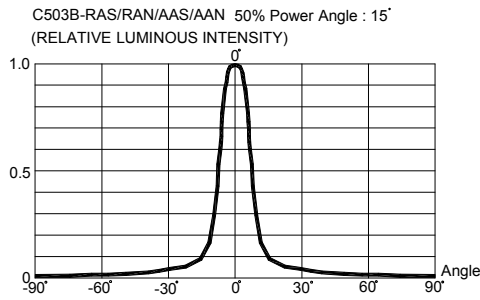

FIG.5 RED & AMBER MAXIMUM FORWARD DC CURRENT VS AMBIENT TEMPERATURE ( $T_{jmax}=110^{\circ}C$ )

## GRAPHS

The data below are collected from statistical figures that do not necessarily correspond to the actual parameters of each single LED. Hence, these data will be changed without further notice.



## MECHANICAL DIMENSIONS

All dimensions are in mm. Tolerance is  $\pm 0.25$  mm unless otherwise noted.

An epoxy meniscus may extend about 1.5 mm down the leads.

Burr around bottom of epoxy may be 0.5 mm max.

**C503B-RAS/AAS:**

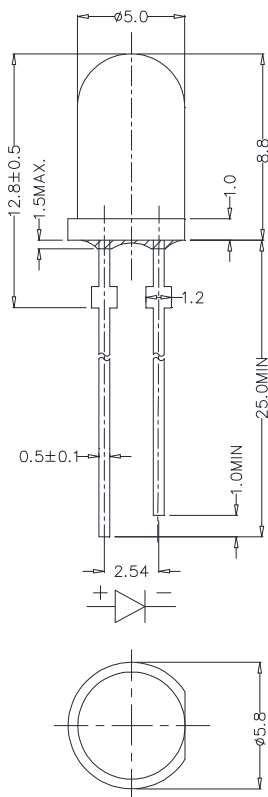

**C503B-RBS/ABS:**

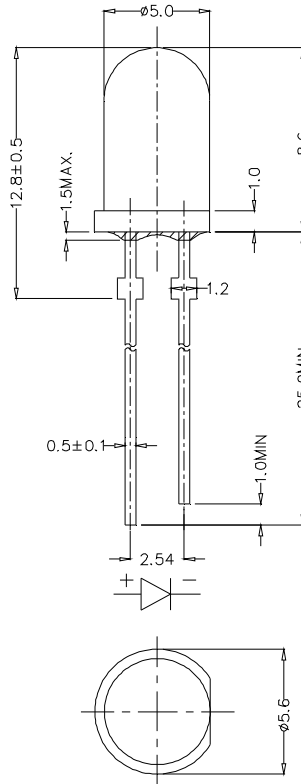

**C503B-RCS:**

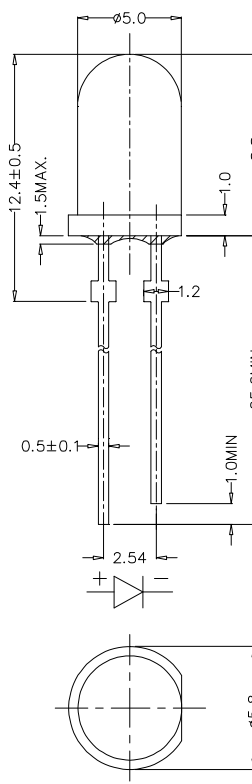

**C503B-ACS:**

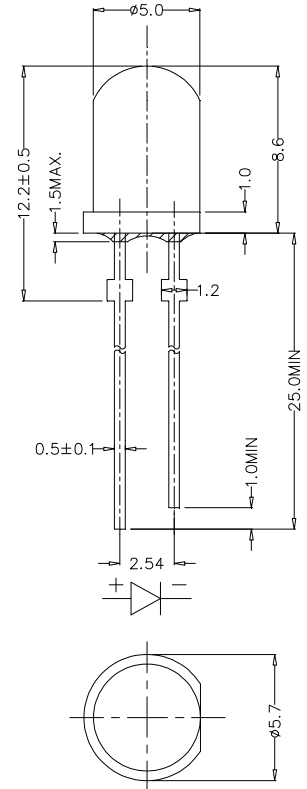

## NOTES

### RoHS Compliance

The levels of RoHS restricted materials in this product are below the maximum concentration values (also referred to as the threshold limits) permitted for such substances, or are used in an exempted application, in accordance with EU Directive 2011/65/EC (RoHS2), as implemented January 2, 2013. RoHS Declarations for this product can be obtained from your Cree LED representative or from the [Product Ecology](#) section of the Cree LED website.

### Vision Advisory

**WARNING:** Do not look at an exposed lamp in operation. Eye injury can result.

## MECHANICAL DIMENSIONS

All dimensions are in mm. Tolerance is  $\pm 0.25$  mm unless otherwise noted.

An epoxy meniscus may extend about 1.5 mm down the leads.

Burr around bottom of epoxy may be 0.5 mm max.

**C503B-RAN/AAN/RCN:**

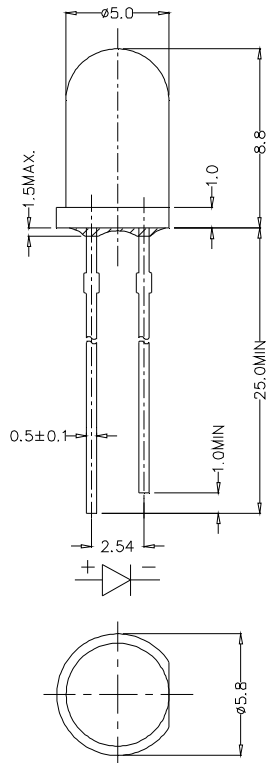

**C503B-RBN/ABN:**

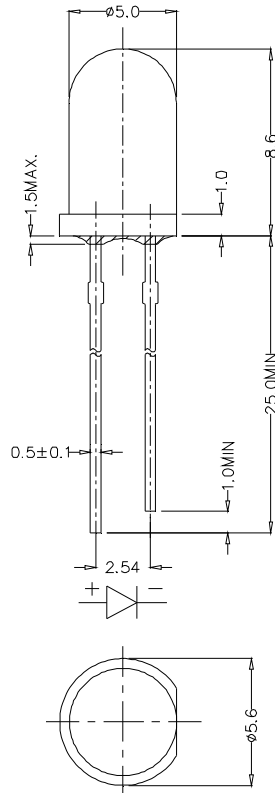

**C503B-ACN:**

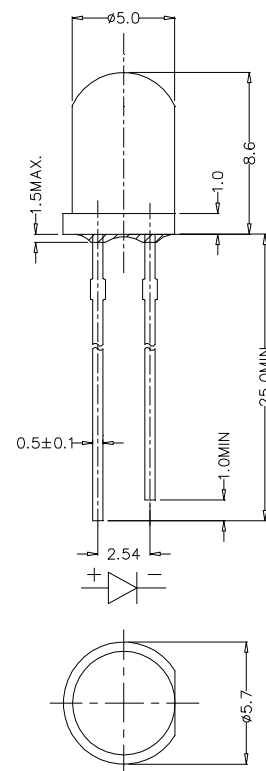

## NOTES

### RoHS Compliance

The levels of RoHS restricted materials in this product are below the maximum concentration values (also referred to as the threshold limits) permitted for such substances, or are used in an exempted application, in accordance with EU Directive 2011/65/EC (RoHS2), as implemented January 2, 2013. RoHS Declarations for this product can be obtained from your Cree LED representative or from the [Product Ecology](#) section of the Cree LED website.

### Vision Advisory

**WARNING:** Do not look at an exposed lamp in operation. Eye injury can result.

## KIT NUMBER SYSTEM

Cree LED lamps are tested and sorted into performance bins. A bin is specified by ranges of color, forward voltage, and brightness. Sorted LEDs are packaged for shipping in various convenient options.

Cree LEDs are sold by order codes in combinations of bins called kits. Order codes are configured in the following manner:

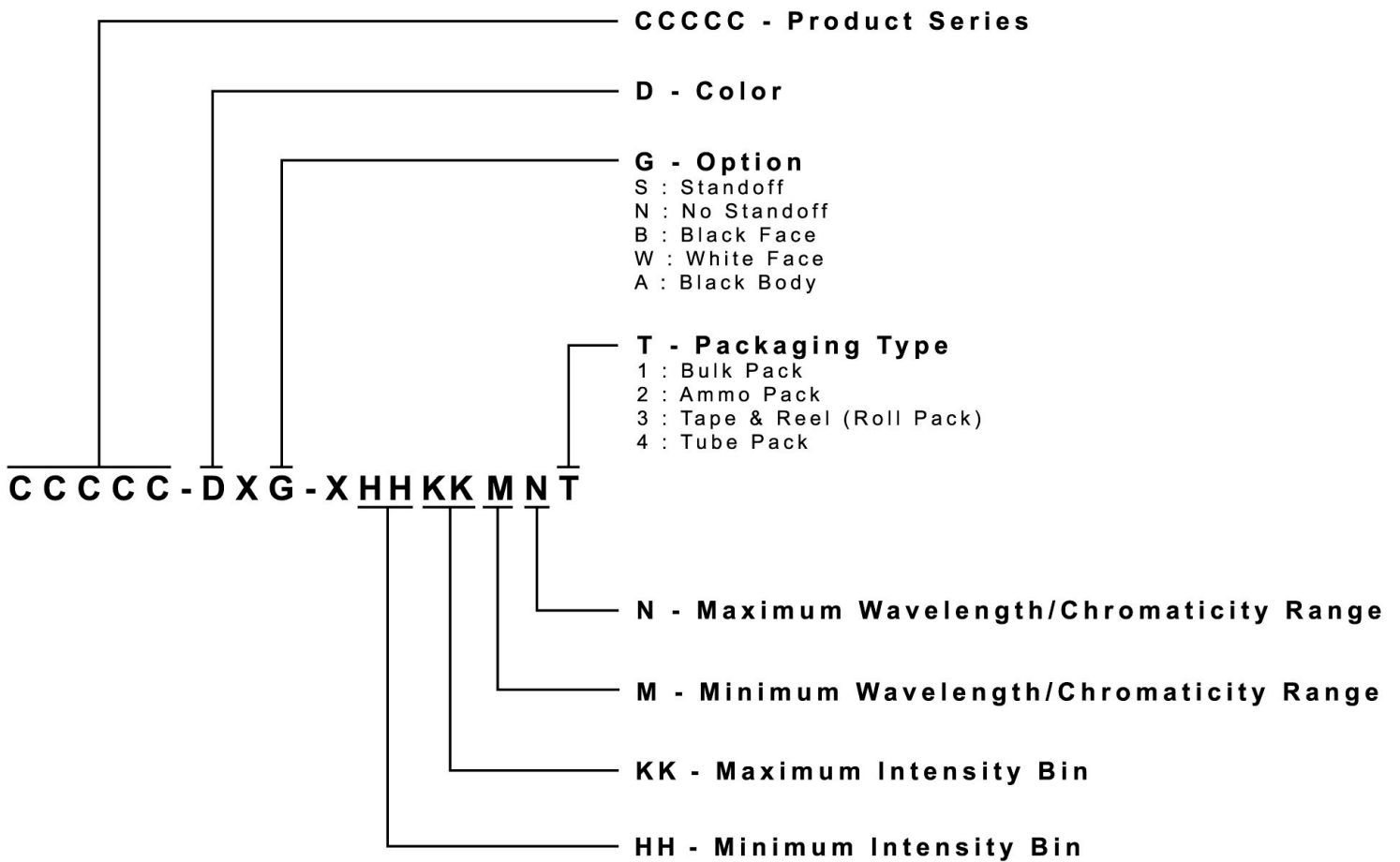

## SOLDERING GUIDELINES

The LED soldering specification is shown below (suitable for both leaded solder & lead-free solder):

| Manual Soldering |  | Solder Dipping          |  |
|------------------|--|-------------------------|--|
| Soldering iron   | 35 W max   | Preheat                 | 110 °C max                                       |
| Temperature      | 300 °C max                                       | Preheat time            | 60 seconds max                                   |
|                  |  | Solder-bath temperature | 260 °C Max                                       |
| Soldering time   | 3 seconds max                                    | Dipping time            | 5 seconds max                                    |
| Position         | Not less than 3 mm from the base of the package. | Position                | Not less than 3 mm from the base of the package. |

- Manual soldering onto the PCB is not recommended because soldering time is uncontrollable.
- The recommended wave soldering is as below:

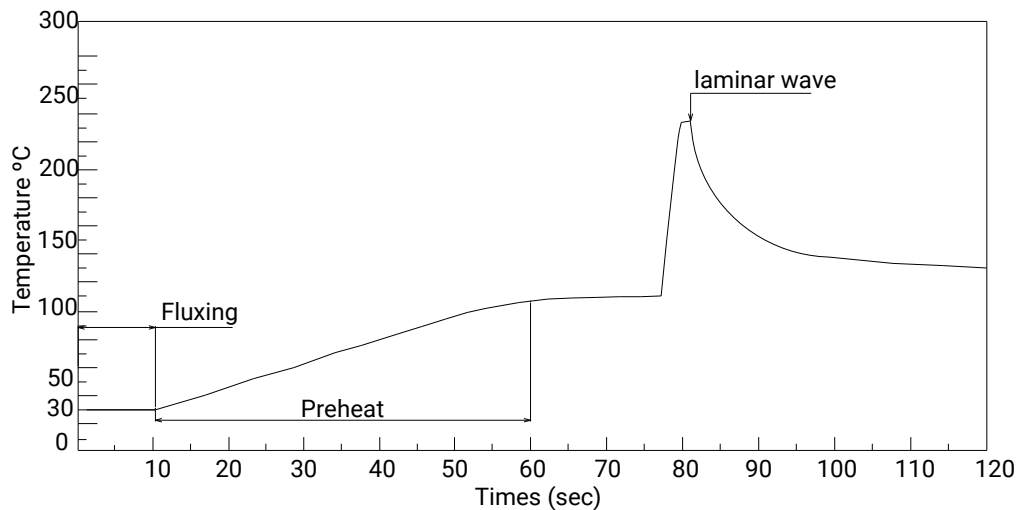

- Do not apply any stress to the LED package, particularly when heated.
- Only bottom preheat is suggested & should not preheat on top in order to reduce thermal stress experienced by the LEDs.
- The LEDs must not be re used once they have been extracted from PCB.
- After soldering the LEDs, the package should be protected from mechanical shock or vibration until the LEDs have reached 40 °C or below.
- Precautions must be taken as mechanical stress on the LEDs may be caused by PCB warpage or from the clinching and cutting of the LED leads.
- When it is necessary to clamp the LEDs during soldering, it is important to ensure no mechanical stress is exerted on the LEDs.
- Cut the LED lead at normal room temperature. Lead cutting at high temperature may cause failure of the LEDs.
- Please refer to the [HB LED Lamp Soldering & Handling](#) document for information about how to use this LED product safely.

## PACKAGING

- The LEDs are packed in cardboard boxes after packaging in normal or anti-electrostatic bags.
- Cardboard boxes will be used to protect the LEDs from mechanical shock during transportation.
- The boxes are not water resistant, and they must be kept away from water and moisture.
- Max 500 pcs per bulk and Max 2500 pcs per ammo.

### Bulk Pack Packaging Type:

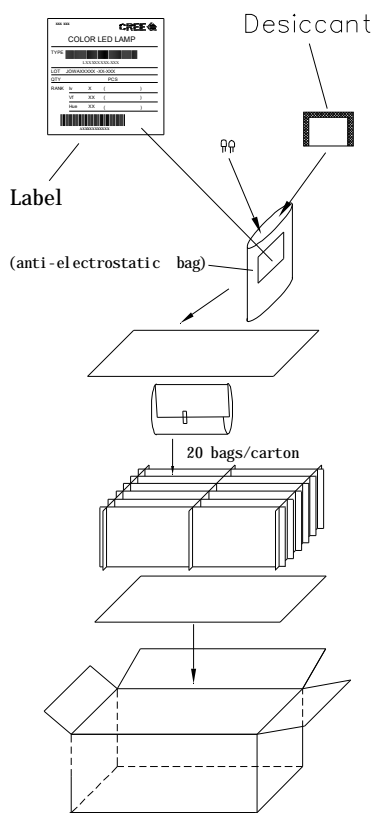

### Ammo Pack Packaging Type:

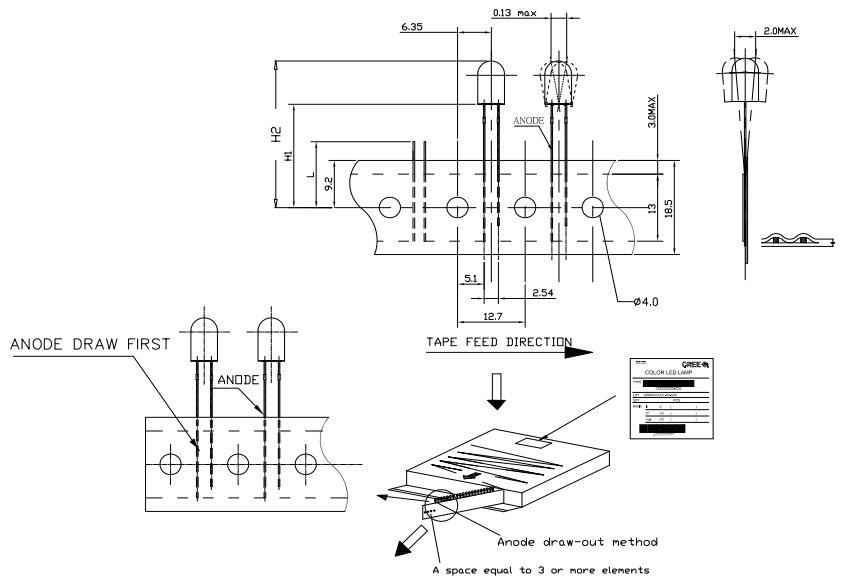

# Mouser Electronics

Authorized Distributor

Click to View Pricing, Inventory, Delivery & Lifecycle Information:

## Cree LED:

[C503B-ACN-CY0Z0252-030](#) [C503B-ACS-CY0Z0252-030](#) [C503B-RBN-CW0Z0AA2](#) [C503B-RBS-CW0Z0AA2](#)  
[C503B-RCN-CW0Z0AA2](#) [C503B-RCS-CW0Z0AA2](#) [C503B-ABN-CW0Z0251](#) [C503B-ABN-CW0Z0252](#) [C503B-ABN-](#)  
[CX0Y0341](#) [C503B-ABN-CX0Y0342](#) [C503B-ABS-CW0Z0251](#) [C503B-ABS-CX0Y0342](#) [C503B-ACN-CX0Y0251](#)  
[C503B-ACN-CX0Y0341](#) [C503B-ACN-CX0Y0342](#) [C503B-ACN-CX0Z0341](#) [C503B-ACN-CY0Z0252](#) [C503B-ACN-](#)  
[CY0Z0341](#) [C503B-ACN-CY0Z0341-030](#) [C503B-ACN-CY0Z0342](#) [C503B-ACN-CY0Z0342-030](#) [C503B-ACS-CX0Z0251](#)  
[C503B-ACS-CX0Z0252](#) [C503B-ACS-CY0Z0251](#) [C503B-ACS-CY0Z0251-030](#) [C503B-RBN-CW0X0AA1](#) [C503B-](#)  
[RBN-CW0Z0AA1](#) [C503B-RBN-CX0Y0AA1](#) [C503B-RBS-CW0Z0AA1](#) [C503B-RCN-CW0X0AA1](#) [C503B-RCN-](#)  
[CW0X0AA2](#) [C503B-RCN-CW0Z0AA1](#) [C503B-RCN-CX0Y0AA2](#) [C503B-RCS-CW0Z0AA1](#) [C503B-RCS-CX0Y0AA1](#)  
[C503B-RCS-CX0Y0AA2](#) [C503B-ABN-CY0Z0341](#) [C503B-RBN-CY0Z0AA2](#) [C503B-RAN-CA0B0AA1](#) [C503B-ABN-](#)  
[CY0Z0342](#) [C503B-RBS-CY0Z0AA1](#) [C503B-ACN-CYAZa341-030](#) [C503B-RCN-CXaYCAA2-030](#) [C503B-RAS-](#)  
[CZ0C0AA1](#) [C503B-RAN-CZ0C0AA2](#) [C503B-RAN-CZ0C0AA1](#) [C503B-RAN-CA0C0AA1](#) [C503B-RAN-CA0C0AA2](#)  
[C503B-RAS-CA0C0AA1](#) [C503B-RAS-CZ0C0AA2](#) [C503B-RAS-CA0C0AA2](#)